

SEAMLESS LUXURY

Exquisite Range of Aluminium Windows and Doors

Fenesta
Better by Design

India's No.1 Windows & Doors Brand





Building a vibrant, growing and resilient Organization



Fenesta is a part of DCM Shriram Ltd., the 131 year old diversified company known for its widespread business in Agri-Rural/Chloro-Vinyl and Value Added Business. DCM Shriram, the 7,771 crore company is one of India's oldest business conglomerate, leading the path of development and innovation. Acknowledged for its transparent work culture and diversity, the entity is managed by a team of highly professional and coherent executives. The company's values have inspired trust and built long-term relationships with stakeholders in India and abroad.

Our Values

I **NTEGRITY**
Uphold ethical standards. Be socially responsible. Deliver on promises.

A **GILITY**
Act with speed. Adapt continuously. Deliver results.

C **USTOMER-CENTRICITY**
Listen to customers. Build long-lasting relationships.

T **EAM WORK**
Foster collaborative working. Promote meritocracy. Practice empathy & humility.

O **PENNESS**
Encourage diverse views. Build external orientation.

N **EWNESS**
Be Innovative. Be Creative.



India's No.1 Windows & Doors Brand

Fenesta, a 'Superbrand', is the leading brand in Windows & Doors in India.

Fenesta pioneered the design, manufacture, installation and service of precision-engineered, 100% customised windows and doors in the country. Today, numerous homes, colleges, hospitals and hotels across the nation are adorned with more than two and half million Fenesta Windows and Doors.

With its unmatched technical superiority and wide range of offerings Fenesta has firmly established itself as India's No.1 Windows and Doors brand with a nationwide presence in more than 327+ cities.

Our Vision

To improve the lives and homes of customers through Innovation and Excellence and be the brand leader in Customised Building Solutions.

Our Mission

To establish a service organisation that passionately provides Customised Building Solutions and delivers Exceptional Customer Experience.



*Creating a
world of infinite
possibilities*





Fenesta Benefits



1000+ styles to suit your needs - 100% customised solutions



In-house Professional Installation Team & 10 Years' Warranty



365 Days Customer Support – Prompt response and resolution through in-house Customer Connect Centre



Strong Sales Network – Nationwide access to unique Fenesta products and solutions



9 Signature Studios - A first-of-its-kind initiative to experience Fenesta products before purchase



Multiple Mobile Studios across India – Mobile showrooms bringing the Fenesta experience closer

Fenesta Edge



Trusted 131 year old, 7,771 crores company



Experience of 2.5 million plus installations across 2 lakh homes



Not just a Brand but a 'Superbrand'



10 Years' Warranty*



Professional Installation



International Design

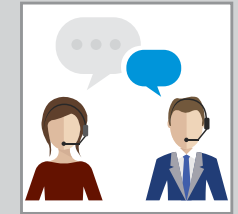

365 Days Customer Support

The Fenesta Solution



Customer Need Identification

Customized Solutions



Survey And Fabrication

Delivery And Installation



Cleaning And Handover

Unmatched After Sales Service



Science@work



Sound Insulation

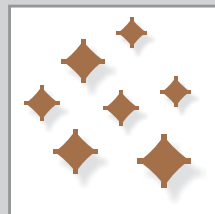

Dust Free Interiors



Energy Efficient - Lowers AC Cost

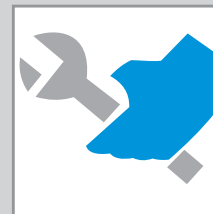

Low Maintenance



Weather proof - Keeps Out Rain*

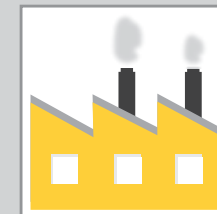

Non-toxic Lead Free



Fenesta Aluminium Series – Seamless Luxury

The newest entrant to the vast Fenesta product portfolio is a luxury range of Aluminium windows and doors.

This series is a minimalist, ultra-modern, style statement designed to enhance the luxury quotient of living spaces.

Aluminium is extremely light with high strength to density ratio. It is sustainable, enjoys superior longevity and enhances the aesthetics.

Characteristics like these have made it a preferred choice for the real estate sector and has been in use since 1930 to construct several iconic landmarks.

Aluminium – The natural ‘Green’ material

After Silicon, Aluminium is the most abundantly available material in nature, i.e. on Earth’s crust. Aluminium can be recycled infinite number of times without losing any of its inherent properties.

In fact, it is 100% recyclable! And what’s more? The recycling can be done at just a mere fraction of the energy consumption of the initial input.

Over the years, the production process of Aluminium has been made even more efficient and the carbon footprint has been reduced by nearly 40%!

Usage of Aluminium as a replacement of wood in windows and doors, reduces deforestation and, in turn, global warming.







Fenesta Aluminium Series – The Informed Choice

The benefits of choosing Fenesta Aluminium Series are truly diverse

A. Minimalistic Design

Fenesta's design philosophy centres around minimalism, an essence of the modern times. Gone are the days of bulky windows and doors occupying large space. Fenesta Aluminium windows and doors are seamless, contemporary and effortlessly elevate the aesthetics. The versatile products transform living spaces with new dimension of substance in simple yet elegant style.

B. Versatile Color Range

You can enhance the color of your home or office interiors with Fenesta Aluminium windows and doors. These are available in 5 colors- White, Walnut, Light Oak, Diamond Grey, Champagne Gold.

C. Design Flexibility

With Aluminium framing options, imagination is limitless. It possesses an inherent strength of flexibility hence making the manufacturing of windows and doors

possible to exact specifications. With an endless array of systems, finishes and glass options, Aluminium offers a vast range of opportunities. From the cost-effective to most elaborate systems, Fenesta Aluminium Series also delivers excellent thermal performance.

D. Durability and Low Maintenance

Aluminium is corrosion-resistant which makes this material low-maintenance. Fenesta's Aluminium windows are resistant to wear and tear caused by the harsh weather. They do not split, crack, swell or lose shape ensuring durability and elongated product life.

E. Recyclability

Aluminium is known to have the highest recycling ability with least amount of energy required. As a result, it is environmentally sustainable and 'green'. This inherent property differentiates it from other framing resources.





Fenesta Aluminium Series - Product Portfolio

Ultra Luxury Series (Thermal Break System)

- Slim Line Slider Doors
- Lift & Slide Doors
- Slide & Fold Doors

Super Luxury Series

- Slider Doors
- Slider Windows
- Casement Doors
- Casement Windows
- Tilt and Turn Windows





Ultra Luxury Series

The Ultra Luxury Series is enhanced with the power of Thermal Break. Built to last and offering high aesthetic value, this range provides solutions to modern day problems of durability by being manufactured using innovative technology and is environment friendly.

Thermal Break

Thermal Break, which is better known as 'insulation within the window' is a continuous barrier between the inside and outside window frames that insulate against heat transfer. The interior and exterior metal frames of the window sash are bonded with a layer of Polyamide that keeps the interior space of windows at a more comfortable temperature, impacting the room temperature as well.

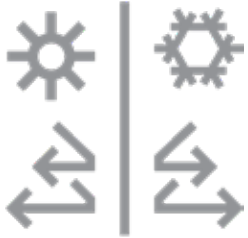



Sleek Finish



Thermal Break System



Corner Slider (90°)





Slim Line Slider Doors (Thermal Break System)

Fenesta's range of Slimline Sliding Doors offers minimally visible aluminium sight lines, which maximises the view you get. With a great balance of functionality and style, these Aluminium doors add exquisiteness to the façades they are used in.

Features

- Thermal Break profile and double thermal break outer frame offers high energy efficiency
- Aluminium frame concealed within the walls, maximising natural light in the room
- Minimal sightlines of 25 mm at interlock and submerged threshold
- Special concealed channel allows for hassle-free water drainage
- Up to 500 Kgs weight capacity – offers the possibility of installing large and special glasses
- Options also available in corner slider

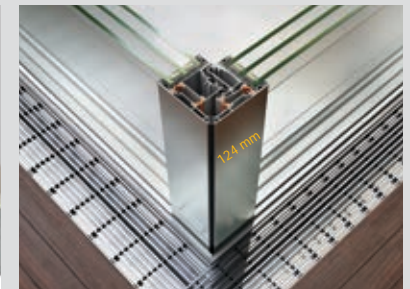
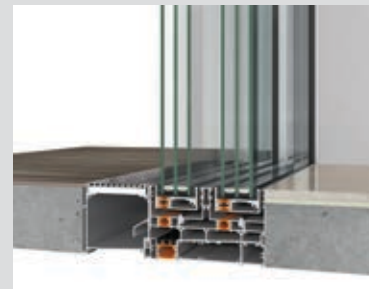



Elegant Finish



Thermal Break System



Large Aperture Size





Lift & Slide Door (Thermal Break System)

Fenesta innovates with the new Ultra Luxury Lift & Slide system. This is a much sought-after choice for covering large spans that link inside with outside. The robust system provides high level of thermal insulation and flexibility in construction because of profile stiffness. These stunning looking doors glide back and forth on feather touch Inox rollers, effortlessly which are incredibly smooth to operate.

Features

- High level of thermal insulation
- Child safety mechanism with dampener
- Large aperture sizes (up to 4 m height and 350 Kgs sash weight)
- Resistance to high speed winds upto 3000 Pa
- Flexible system – 2 track and 2 track with mesh





Elegant Finish



Submerged Threshold



Unobstructed View





Slide & Fold Door (Thermal Break System)

Thermal Break Slide and Fold Aluminium Door by Fenesta can open partially for easy access or wall to wall for an unobstructed view. These doors are energy efficient, built to last, and provide better ventilation along with enhanced heat insulation to keep the temperature cool inside. Seamlessly blending your home's interiors and exteriors, Fenesta's thermal break Slide and Fold Doors will change the way you see doors.

Features

- Efficient heat insulation
- Submerged Threshold: easy accessibility of wheelchair
- 125 Kgs Weight Carrying Capacity per sash, allows higher glass weight & size
- Provides for expansive opening

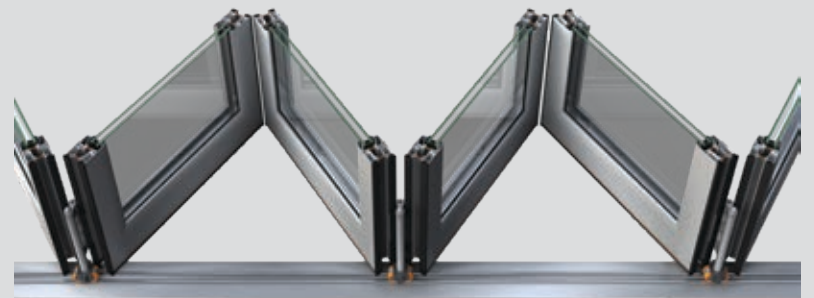





Super Luxury Series

Fenesta introduces Super Luxury Aluminium Windows that deliver a minimalist and ultra-modern style statement. With styles ranging from casement to tilt and turn to sliding windows, these Aluminium Windows are premium in design while offering diversity in use. Featuring slimmer frame and widths along with more glass area, this range of Aluminium Windows by Fenesta helps set the tone to create brilliant spaces.



Graceful Lines



Slim Interlocks



Smooth Sliding Operations





Slider Door

The Sliding Doors offered by Fenesta are in perfect harmony with modern architectural styles and score high on functionality. With exceptionally graceful lines, an easy gliding operation and a robust design language, Aluminium Sliding Doors by Fenesta are sleek and practical in the same breath.

Features

- Slimmest in class interlock of 23 mm to maximise visibility and natural lighting
- Meeting sash interlock 62 mm (Slimest in class)
- High Quality Stainless Steel rails for smooth sliding operation
- Heavy duty rollers to withstand weight up to 200 Kgs





Unobstructed View



Easy Locking Operation

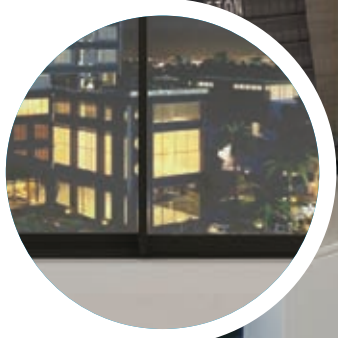

Smooth Operation





Slider Window

Offering the convenience of ventilation as well as unobstructed views, Aluminium Sliding Windows by Fenesta have the lightest sliding system, which is quite easy to operate. These sliding windows are sleek and work well with a multitude of architectural styles by adding a sense of flair to them.

Features

- Unobstructed views
- Prevents dust, pollution, and noise
- Interlock sightline of 32 mm and meeting sash interlock 72 mm
- Recommended for small, medium or large spans





Elegant Finish



3m Height



Double Glazing





Casement Door

Counted among the most popular door designs, Aluminium Casement Doors introduce a classic look in even the most modern of settings. Designed to swing inwards or outwards with the twist of a handle, casement doors offer clear views of the other side. Above all, it's their picturesque profile that makes casement doors the preferred choice for many.

Features

- Triple sealing to keep out dust, noise, seepage and pollution
- Low and No Threshold variants available
- Single and Double glazing options
- Wide range of Custom designs
- Door height of up to 3 m

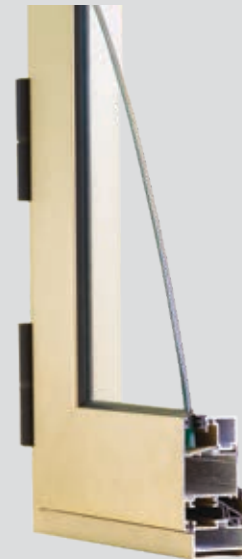

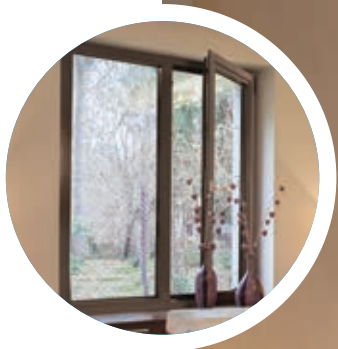

Classic Design

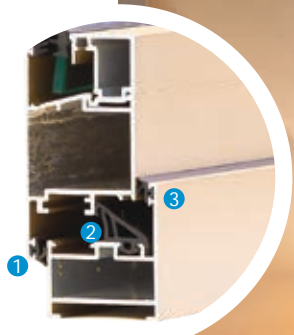

Triple Sealing



Double Glazing





Casement Window

A contemporary take on a classic design, Aluminium Casement Windows by Fenesta exhibit style in simplicity. These windows are easy to open and offer an unobstructed view of the outside. Available in customised designs, Aluminium Casement Windows by Fenesta are a practical choice for many homeowners, elevating the aesthetics of any space they are installed in.

Features

- Insulation against seepage: Drip bar doesn't allow water inside
- Multi-point locking for enhanced security
- Triple sealing to keep out dust, noise, seepage and pollution
- Single and Double glazing options
- Frame width: 45 mm used on slim aperture





Controlled Ventilation



Multi Point Locking



Double Glazing





Tilt and Turn Windows

Advocated by designers and architects alike, Tilt and Turn Aluminium windows by Fenesta possess versatility in design - Tilt it for controlled ventilation or Turn and open it in a conventional manner. Add a new dimension of design and substance to your home with Fenesta's Tilt and Turn Aluminium Windows.

Features

- Brings in maximum sunlight and has great aesthetics
- Triple sealing to keep out dust, noise, seepage and pollution
- Noise insulation, weather resistance
- Contemporary and stylish designs
- Tilt position allows draft-free ventilation and rain protection
- Turn position offers maximum ventilation and quick cleaning



Awards & Accolades



Only Window Brand in the country to be conferred with Superbrand status for four consecutive years (2015-2019)



Best modular windows category based on consumer survey conducted in April 2019



Extraordinaire Brand Award at Brand Vision Summit, Mumbai 2019



Named among best building products ranked by Leading Architects & Designers



Most Admired Brand of the Year Windows & Doors at ET Now Star of the Industry Awards, 2019



The 2018 DMA Asia ECHO Awards for Customer Acquisition through Digital Marketing



Honoured with Asia One India's Greatest Brand for 2017-18 in Windows & Doors category



Bagged the Product brand of the year 2019 for excellence in building products and construction material sector at Realty Plus Interior & Exterior Awards, 2019



Won Brand of the year in uPVC windows category & most preferred brand by real estate sector in uPVC windows & doors (Year 2017-18)



Won the prestigious Product of the Year 2015 award by ABID (Association of Architects Builders Interior Designers and Allied Business)

Accreditations Summary



British Standard Institution, UK



The extrusion facility in Kota conforms to ISO 9001, ISO 14001, OSHAS 18001



Central Building Research Institute, Roorkee



Das Kunststoff - Zentrum



Center for Environmental Planning & Technology, Ahmedabad





Extrusion plant at Kota is the recipient of the British Sword of Honour for its unblemished safety record (Year 2009)



First in the Indian Window Industry to be certified for ISO 9001, ISO 14001 & ISO 45001







भारत सरकार
GOVERNMENT OF INDIA
पेटेंट कार्यालय
THE PATENT OFFICE
पेटेंट प्रमाणपत्र
PATENT CERTIFICATE
(Rule 74 Of The Patents Rules)

क्रमांक : 011110090
SL No :



पेटेंट सं. / Patent No.	:	305161
आवेदन सं. / Application No.	:	2691/DEL/2006
फाइल करने की तारीख / Date of Filing	:	15/12/2006
पेटेंटी / Patentee	:	FENESTA BUILDING SYSTEMS

प्रमाणित किया जाता है कि पेटेंटी को उपरोक्त आवेदन में यथाप्रकटित 'WINDOW AND DOOR SYSTEMS FOR BUILDINGS IN HIGH WIND AREA WITH HEAVY RAIN' नामक आविष्कार के लिए, पेटेंट अधिनियम, 1970 के उपबंधों के अनुसार आज तारीख 15th day of December 2006 से बीस वर्ष की अवधि के लिए पेटेंट अनुदान किया गया है।

It is hereby certified that a patent has been granted to the patentee for an invention entitled 'WINDOW AND DOOR SYSTEMS FOR BUILDINGS IN HIGH WIND AREA WITH HEAVY RAIN' as disclosed in the above mentioned application for the term of 20 years from the 15th day of December 2006 in accordance with the provisions of the Patents Act,1970.



INTELLECTUAL PROPERTY INDIA
PATENTS | DESIGNS | TRADE MARKS
GEOGRAPHICAL INDICATION

अनुदान की तारीख : 31/12/2018
Date of Grant :

पेटेंट नियंत्रक
Controller of Patent

टिप्पणी - इस पेटेंट के नवीकरण के लिए फीस, यदि इसे बनाए रखा जाना है, 15th day of December 2008 को और उसके पश्चात प्रत्येक वर्ष में उसी दिन देव होगी।
Note. - The fees for renewal of this patent, if it is to be maintained will fall / has fallen due on 15th day of December 2008 and on the same day in every year thereafter.

Patent received for High Wind & Heavy Rain windows & doors system





Shriram Institute for Industrial Research

(A Unit Of Shriram Scientific & Industrial Research Foundation)

EXPLORE MORE WITH THE AR ENABLED FENESTA APP



  Scan to download the app

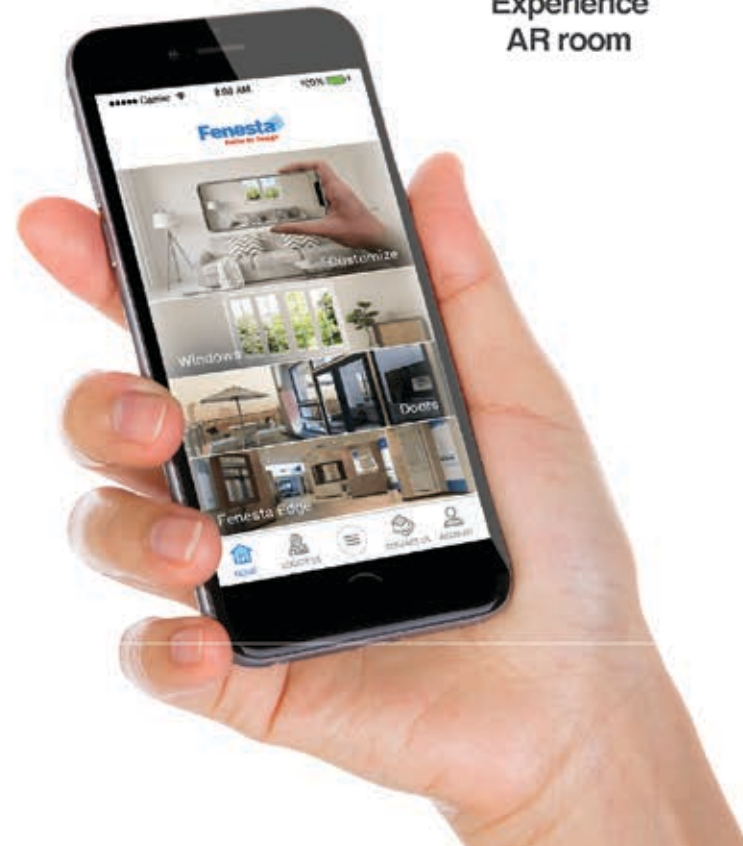

Our Clientele

Residential



Crest NCR, Belair NCR,
Park Place NCR
OMR Chennai, Vytilla Cochin
& NTH Calcutta



Shantiniketan Bangalore,
Abshot - Bangalore, Bougain
Villa - Bangalore more



Atlantis - NCR, Pirangut
Villas - Pune



Blue Sapphire - Kolkata



Iconic - NCR, Mezzaria -
NCR, Moderne - NCR



Twin Towers - NCR,
Forest Spa - NCR



Solitaire - Hyberabed



Klasse - NCR



Woodsman Estate - Bangalore



Chloris - NCR, Aura - NCR



Stylome - NCR, Edifice - NCR



Millenium - Bangalore,
Gardenia - Bangalore,
Splendor - Bangalore,
Harmony, Paramount more



Blue Mont - Chennai,
West Hills - Chennai

Hotels



Cochin, Landsend, Mumbai,
Hyderabad



NCR



NCR



NCR



Bangalore



Pune, Ahmedabad, Chennai



Gurgaon, Goa, Ahmedabad,
Mumbai



NCR



Bangalore, Goa, Hyderabad



Ahmedabad, Indore



NCR

Hospitals



NCR



Mumbai, Bangalore



Chennai



Mumbai



Mumbai



NCR



NCR

Fenesta Selected Colors

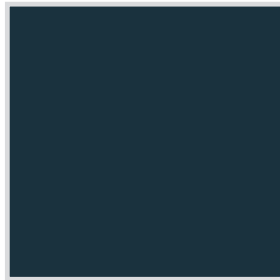

DIAMOND GREY

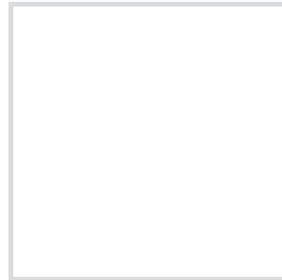

PRISTINE WHITE



CHAMPAGNE GOLD



LIGHT OAK



WALNUT

Accessories (Handles)



CASEMENT DOOR HANDLE
Avl. Colours - Titanium, White & Black



D HANDLE
Avl. Colours - White & Black



LIFT & SLIDE HANDLE
Avl. Colours - Titanium, White & Black



OFFSET HANDLE (LEFT & RIGHT VARIANT)
Avl. Colours - Titanium, Black & White



SLIDER WINDOW FLUSH HANDLE
Avl. Colours - Black & White



SLIMLINE HANDLE
Avl. Colour - Matte Black



STRAIGHT HANDLE
Avl. Colours - Titanium, White & Black



PATIO FLUSH
Avl. Colour - Black



PATIO FLUSH
Avl. Colour - White





India's No.1 Windows & Doors Brand

Nationwide Footprint: Service across 327+ cities

Call: 1800 102 9880 |  92053 52006 (Toll Free), **SMS:** WINDOW to 56161, **Email:** response@fenesta.com, **Visit:** www.fenesta.com



Your One Stop Solution

Fenesta Doors - get the edge over traditional doors.



Fenesta 
Better by Design

India's No.1 Windows & Doors Brand

India's No.1 Windows and Doors Brand

Fenesta is a part of DCM Shriram Group established in 1889 with a turnover of over ₹ 9,849 crores. Acknowledged for its transparent work culture and diversity, the integrated business entity's values have inspired trust and built long-term relationships with stakeholders in India and abroad.

Fenesta - India's No.1 brand for windows & doors was launched in 2002. No other company in the country draws from world-class infrastructure or has complete control over the entire supply chain of window & doors manufacturing and installation like Fenesta. It takes all-round expertise in extrusion, design, planning, fabrication, delivery and installation to produce high performance, world-class windows and doors.

With a presence in over 350+ cities across India, Fenesta has the unique distinction of over 3 million installations.



The Engineered Wooden Doors: In a class of its own

When it comes to doors, the first material that comes to mind is wood. However, all its advantages notwithstanding, there are riders that come along with it. You have to contend with issues like the quality of wood, the finishing, disparity in colours, insect-proofing, warping and bloating and seepage of rain water.

Add to this, the hassle of contacting multiple vendors, choosing the wood type and quality, installation and worrying about the final outcome. Not to forget, the manual work done from the carpenter would miss the dimensional accuracy and would result in uneven finish to the product. Even after this, you can never be sure of its durability and overall quality.

Fenesta, a pioneer of branded Windows and Doors category has a vast experience of delivering excellence and continuous innovation. Fenesta has been constantly providing the best quality, customer satisfaction, experience and unmatched service capabilities. With Engineered wooden Doors, Fenesta is further going to revolutionize the category with unique offerings, impeccable service and best in class quality which customers have been missing so far.

Traditional Ways of Making Wooden Doors are Losing Relevance

Wood has traditionally, been the material of choice when it comes to doors or furniture. But today it comes with its own set of challenges such as: Selection of the right wood and getting assurance for its genuinity. Whether the wood has been curated to withstand seasonal setbacks of bloating and warping? How will it be installed? And most importantly, how many different people or vendors you have to deal with to get that perfect door for your home? It is no surprise, that people are now refraining from installing wooden doors at their homes.

Complex and Cumbersome Process of Carpenter Made Doors



1

WOOD SELECTION

No assurance of wood genuinity, quality and durability



2

LABOUR

Hassles involved in getting the transportation done



3

ISSUES WITH MANUAL WORK

No assurance of consistency in the making of door & frame



4

ACCESSORIES

Cumbersome process of selecting different accessories from different vendors



5

PAINT AND POLISHING

No guarantee of longevity and precision of manually done paint or polish



6

PASTING OF LAMINATE/VENEER

Manual pasting with glue results in peeling of laminate/veneer



7

INSTALLATION

On site fabrication turns home into a workshop and can damage floors too

Fenesta Doors

One Stop Solution



Unmatched strength and durability



Tailored fit



Wood quality assurance from Fenesta



Lifetime after sales service



Mindful Towards Sustainable Future

Being a brand, which is responsible towards our planet and focuses on green building solutions to encourage environmentally mindful workplace, invest in sustainable harvesting of trees. Sustainability being the key to a better future, is in our hearts and our wood is sourced legally to encourage the betterment of our planet.

Fenesta makes sure that the wood which is being used, is Sourced from ethical, legal, sustainably managed and FSC certified sources. With a vision to transform homes and to add value to the lives of our customers, the innovations we bring, are in alignment with the betterment of the planet which we adore.

Fenesta Edge



Made with Hardwood: Durability, easy maintenance, strength, finishing and has higher fire-resistance than soft wood.



Responsible Sourcing: Imported from regions where the wood is grown legally ensuring sustainability and quality.



One Stop Solution: Design, manufacture, professional installation, accessories & services happen at one point of contact.



Commitment on warranty Products are covered under Fenesta assured warranty



Unmatched Finish: Machine polish gives uniformity and longevity. No re-polishing required for 10 years.

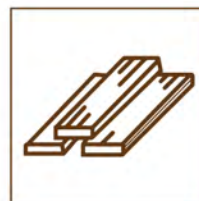

Best in Class treatment of wood: Moisture treatment of Timber for 45 days to avoid seasonal behavioral changes.

Fenesta Edge



Best Wood Type: Only Teak and Steam Beech known for its inherent qualities of texture, strength, durability etc. are used.



100% Factory Made: This ensures superior finish, precision, quality and zero on-site mess.



100 + Styles, 100% Customised Size: Choose and customise as per your specific requirements.



Unmatched Strength and Quality: ISO 2202 Certified Genuine Wood. Edge Banding on veneer and laminate doors.



UV Curing: It significantly reduces finishing process times while providing superior durability due to improved abrasion, chemical, and stain resistance.



Dimensional Accuracy to the finished product with Door seal to avoid the door from banging.

Finished to Perfection. Made to Last.

Panel Options to Choose From

Veneer

The natural and aesthetically pleasing grain patterns of Veneer offer admirable look and highlights the simplicity and natural beauty of wood. The different range of colors available in veneers sets an ambient of the room where Doors are installed in.

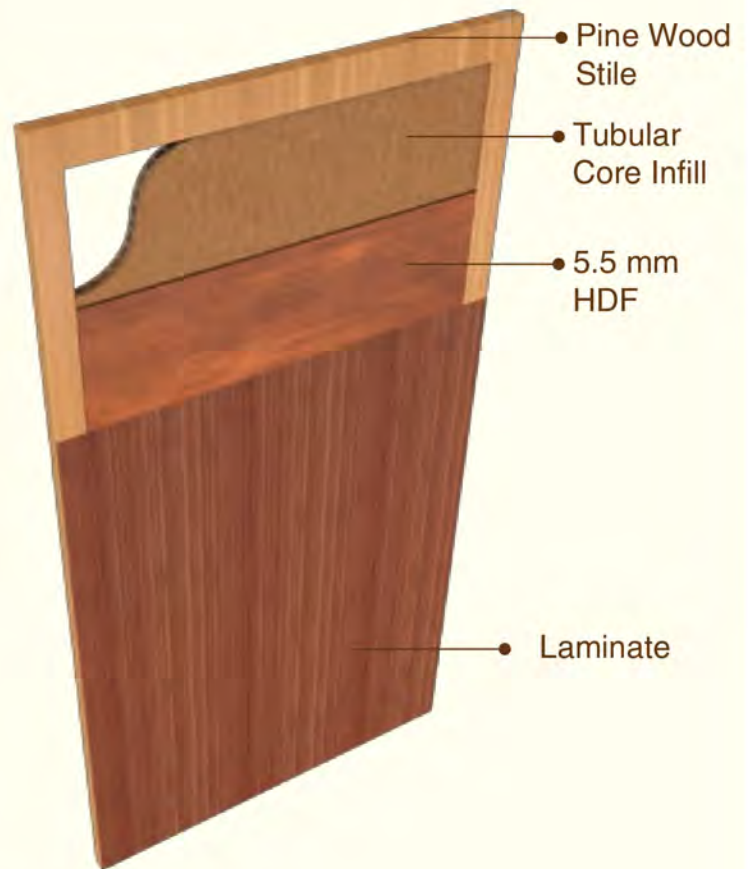
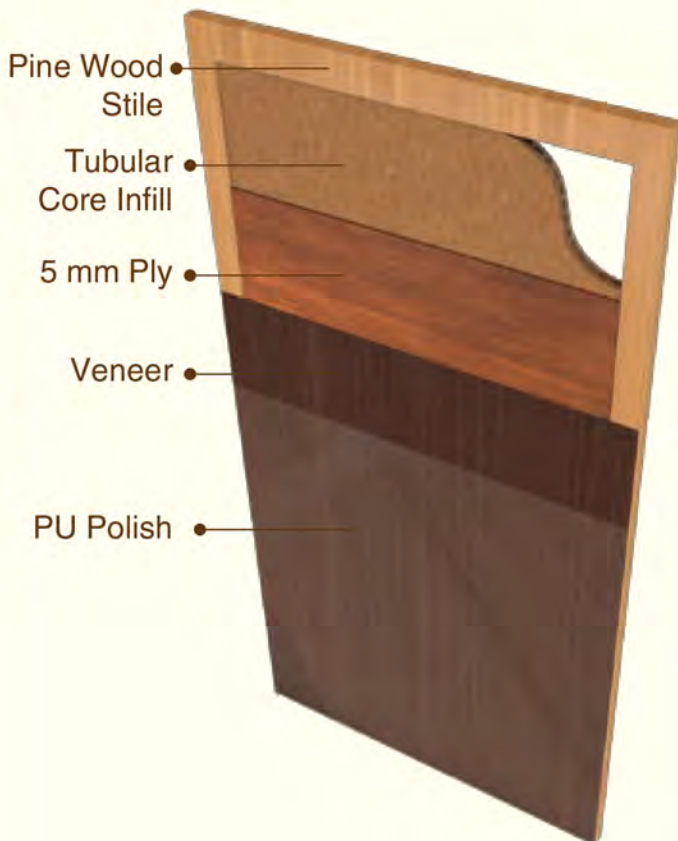

Laminate

The laminates are artificially made and comes in various colour options. The durability and ease of maintenance along with aesthetics adds more beauty to the installed Doors.

Frames and Architraves

Frames

Fenesta Wooden door frames are made using high quality wood and are factory finished to match the aesthetic look of the door leaf and give a symmetrical look to your vision as colors are matched with perfection.

100x40 mm



100x60 mm



150x60 mm



Architrave: Available in Teak and Steam Beech

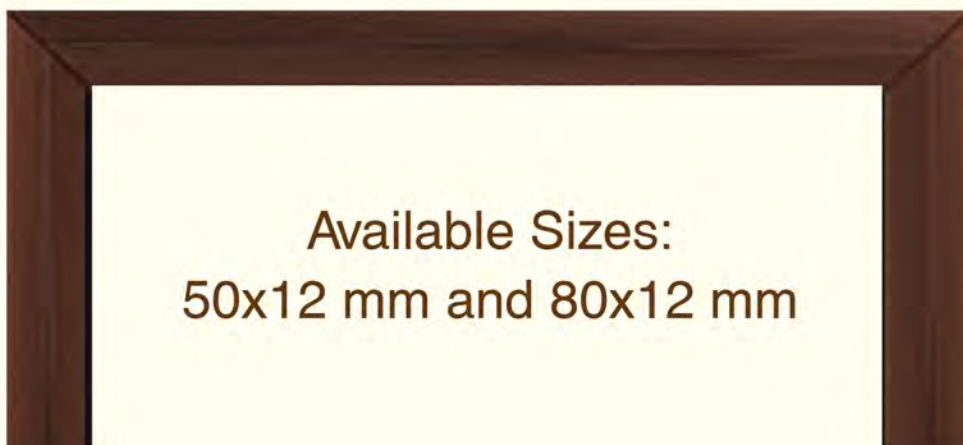

Range, Designs and Colours



Colour Palette



Dark Oak



Walnut



Mahogany



Light Oak



Pristine White

Dimensions



100% customisable solutions as per the requirement of the site.

Handle & Other Accessories

Branded Handles and Locksets

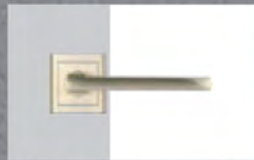

Available in Silver chrome, Antique brass and Matt black colour

Accessories on Request



Digital Lock



Tower Bolt



Door Closer



Entrance Lock

And more



The Promise of Convenience

Choosing Fenesta gets home convenience unlike the tedious cycle of traditional door making. We have a hassle-free, easy and smooth process that un-complicates your life.



FACTORY MADE
Fenesta has factory made doors that come with frame and accessories. No involvement of retailers or wood suppliers.



NO ONSITE MESS
No onsite mess of painting, polishing, breaking or cutting shapes at site.



TRAINED PROFESSIONAL VISIT IN ADVANCE
Trained professionals take measurements in advance and install the factory made doors.



TRANSPORTATION
Fenesta provides easy transportation to your door step



HASSLE-FREE INSTALLATION
Convenient and hassle-free professional installation without unnecessary chaos of labour or carpenters.



MAINTENANCE FREE
Fenesta Doors are maintenance free and does not require much care. 365 days customer care also available for any help.

ONE-STOP SOLUTION

CONVENIENT & EASY PROCESS WITH GUARANTEED QUALITY

Explore More With The AR Enabled Fenesta App



Select window or door



Choose space/area - kitchen, bathroom, bedroom, balcony, drawing room etc.



Choose the type of window and colours

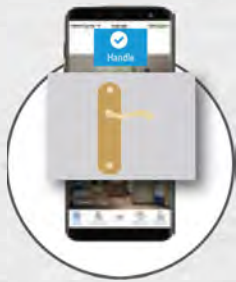

Select handle / mesh



Experience AR room



Scan to download the app
Compatible with  android and  iOS





Immersive 3D VR Enabled Walk through of Our Signature Studio

Scan the QR code or visit www.fenesta.com

Walk through can be taken from



Desktop



Tablet



Mobile Phone



VR Gear

Book an appointment with our sales team to give you a VR Enabled walk through from the comfort of your home. Call: 1800 102 9880 |  74286 91568



Scan here



India's No.1 Windows & Doors Brand

Nationwide Footprint: Service across 350+ cities

SMS: WINDOW to 56161 | **Email:** response@fenesta.com

Visit: www.fenesta.com | **Call:** 1800 102 9880 |  74286 91568





Keep the Outside Outside Forever



Well-made, well-specified and carefully designed to enhance the value of your home, Fenesta windows and doors improve the façade and indoor aesthetics, and elements of architectural style that alter the character of bedrooms, the living room, the dining room, the study and even the kitchen and bathrooms. They are stylish, elegant looking, smooth to touch and effortless to operate. Moreover, they insulate homes from noise, rain, dust and pollution, transforming your abode into a peaceful retreat.

With these wide-ranging skills, India's leading Windows and Doors Brand Fenesta, produces The World's Finest Windows and Doors for The World's Finest Homes.

Window Innovations

The brand Fenesta is built around you. Built on a heritage of quality and innovation, we are continuously leading the industry with product design and function. Each product is made to order, one at a time to meet your exact specifications. With our customisation capabilities, exclusive innovations, high performance and energy efficient options and our unmatched personal service at every point in the process, you will be able to find beautiful windows and doors for your dream project.

Some of our major innovations are as:

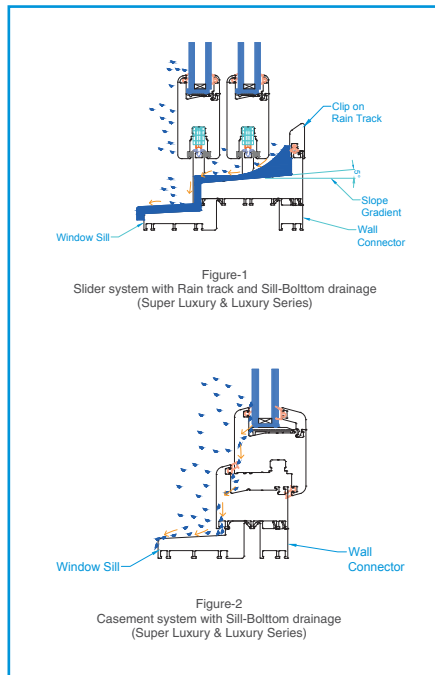

Innovation # 1

The Rain Track – Barrier against Extreme Monsoon

Conventional 'face drainage' mechanism

In coastal areas, 'monsoon precipitation rates' are extremely high. Worse, the monsoon storms arrive on the back of high velocity winds. The combined force of the wind and the rain annihilates conventional windows. The force is magnified in high-rise buildings, where rain spears in at a sharp 45° angle, accompanied by a gale storm.

Conventional solutions don't work

The 'face drainage' mechanism in conventional uPVC windows is inadequate for heavy monsoon areas as the force of the wind pushes the rainwater indoors (see illustration).

Fenesta has engineered three innovations to keep the rain out

- **Rain track:** An elevated section clipped on the inside track of the window functions like a dam. It captures rainwater and drains it out
- **Sill arrangement:** This special system prevents air pressure from pushing the rainwater indoors. Instead, the rainwater flows down vertically, at some distance from the outer wall
- **Gradient slope:** A track at a downward slope ensures accumulated rainwater flows out

Innovation # 2

The Hurricane Bar - Barrier against Strong Winds

Wind speeds in India are much higher than those of other parts of the world (see map). Along the coast, in the east and the west, wind speeds touch 200 kmph, the equivalent of 2000 Pascal wind loads.

In these conditions, conventional windows rattle and whistle.

It gets worse in high-rise buildings. What appears to be a mild breeze on the ground floor becomes a gale force in the upper reaches of a tall building. Only Fenesta windows can cope; conventional ones cannot.

Fenesta engineers an air tight solution

Fenesta Super Luxury & Luxury Series have broad sections reinforced with steel and further strengthened with a special Hurricane Bar.

The Hurricane Bar doubles up as a handle.

Multiple seals stop air ingress. No more whistling and rattling sounds even at 3000 Pascal wind loads.

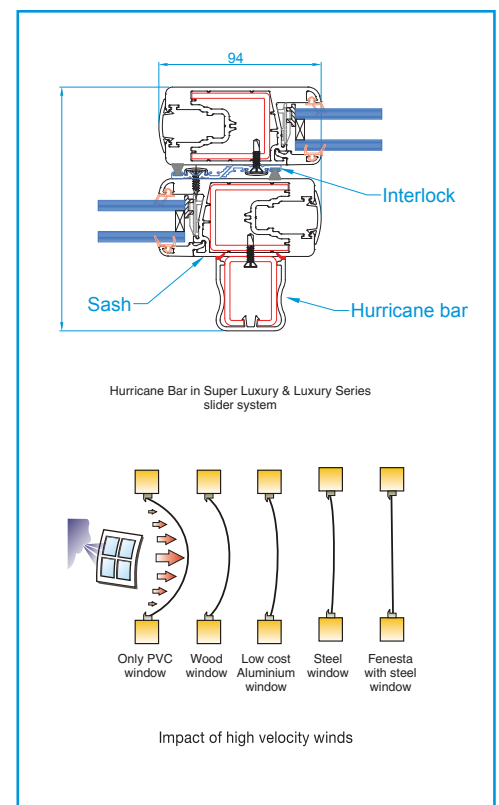
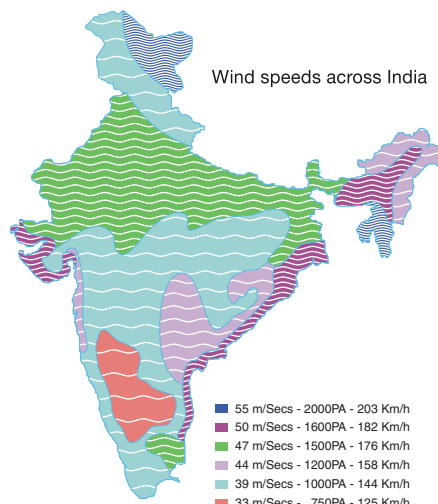

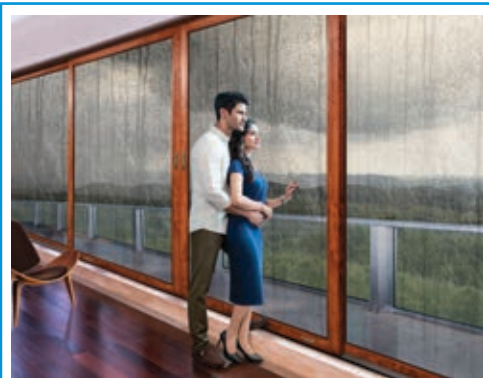

Fenesta slider door and combination of fixed and slider door in Walnut finish



Global Radiation in kJ/year
Global radiation: Note the intensity in India
Data provided by the Surface Radiation Budget Project at NASA Langley Research Center.

Innovation # 3

The Tropical Formulation Barrier against Indian Weather

India happens to be situated in one of the highest UV receiving regions of the world. Solar radiation is far higher in India than other parts of the world.

India also experiences climatic extremes. In summers, temperatures soar as high as 50°C in the northern parts of Gangetic Plains, Rajasthan and Gujarat. In winters, temperatures in the hills often fall below freezing point.

To withstand the severity of these conditions, Fenesta has created a special uPVC blend, a unique tropical formulation that stands up to extreme radiation year after year.

The Fenesta uPVC blend has won BSI approval under extreme weather conditions simulated for 6000 hours. For Europe, a similar test is carried out for only 4000 hours.

Special additives: The Fenesta uPVC innovation for India

- **Titanium Dioxide:** High dosage of TiO₂ results in ongoing colour stability in the face of intense ultraviolet rays. Fenesta takes a color fading guarantee ($\Delta E < 5$), not perceptible to the naked eye
- **Impact modifiers:** These impart additional strength to window profiles, giving them the necessary muscle to carry huge loads

Innovation # 4

The Fenesta Customization Made only for You

Fenesta window systems are modular in nature like a Lego set. Combinations of different components make possible countless designs, shapes and sizes, from the modern to the traditional.

Seamless combinations of sliders and casements

This special feature integrates fixed and sliding windows in a single plane without any thick sight lines.

Large sizes

Modern homes have fewer walls and more windows. Fenesta frames can be made to stretch from the floor to the ceiling and span balconies, adding a sense of space to living areas. The strength of a window is determined more by the size of the reinforcement and less by the thickness of the profile. The Fenesta Villa Window too presents a rare combination of style, substance, sealing and security in sizes that span walls.

Design freedom

Extend your design palette, from casements and sliders to combinations of fixed, sliders and casements, tilt & turn windows, bay windows and even corner windows with glass-to-glass joints.

Colour options

- Make your selection from a range of rich wood finish colours (Light Oak, Walnut, Mahogany and Dark Oak) apart from Pristine White, Silver Brush, Flemish Gold and Black.

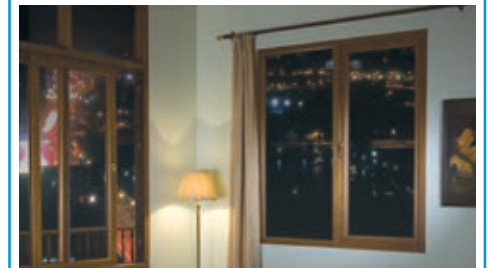
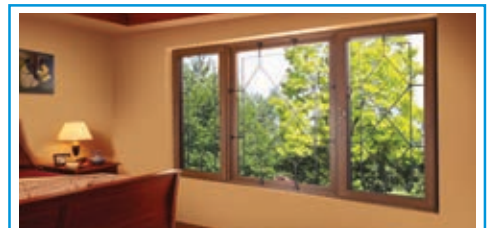

Cross section of seamless combination of slider and casement window

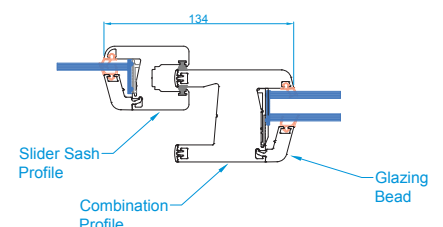

Standard Fenesta colours



Pristine White



Silver Brush



Flemish Gold



Light Oak

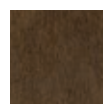

Walnut



Mahogany



Dark Oak

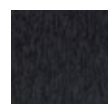

Black

Innovation # 5

Energy Efficient – The Green Windows

“An energy saving window can save nearly 30% energy”, says Prof. N.K. Bansal, Center of Energy Studies, IIT Delhi.

In his expert view “an energy saving window consists of (i) a heat insulating framing material, (ii) double-glazing and (iii) proper sealing between wall and window as well as between the opening and fixed framing of the windows.” Fenesta is modeled on these precise lines.

Fenesta: The anatomy of a green window

- **Heat insulating uPVC frame:** uPVC is a poor conductor of heat unlike windows made of steel and non-thermal break aluminium that have a higher U-value
- **Better sealing:** Fenesta windows are fusion welded and can be equipped with a multiple-point locking system for excellent sealing
- **Sealing between wall and window:** Fenesta uses silicone sealants to seal all gaps between the walls and windows for better insulation
- **Glazing:** Double glass (or even triple glass in some cases) further improves insulation

Environment friendly

- uPVC has a lower environmental impact in its production

Material	m ³ of air/Kgs	dm ³ water/Kgs
PVC	700	3000
Steel	3400	4600
Low Cost Aluminium	9320	27700

Source: Environmentally friendly packaging in the future. Stichting Milieudefensie (NI), 1991

Energy used in Gjoules/ton	
Material	Energy use
PVC	53
Steel	30
Low Cost Aluminium	200

Note: Low Cost Aluminium is extruded cold which is more energy intensive. Source: Environmentally friendly packaging in the future. Stichting Milieudefensie (NI), 1991

Material	U-value (Watt/m ² °K)
Timber	2.66
Non-Thermal break Aluminium	4.92
PVC	2.60

Comparison of thermal properties of various window framing materials

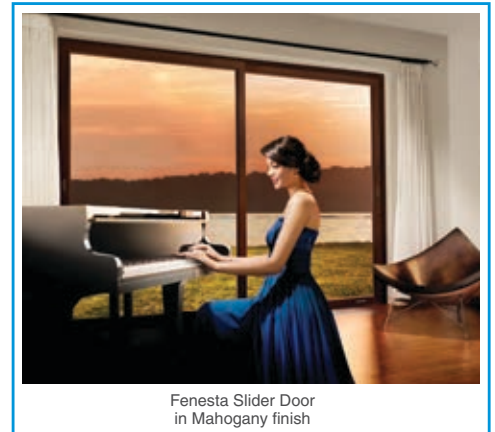

Fenesta Slider Door in Mahogany finish

- uPVC reuse is the norm
- Fenesta uPVC blend (strengthened with special additives) does not require any painting, eliminating the consumption of paints that can emit harmful chemicals
- Long life: The life of a Fenesta uPVC window is equivalent to the life of a building

Green Building Certification

Fenesta windows can contribute to both LEED and GRIHA credit points.

Innovation # 6

The Villa Window

Fenesta technology has made the traditional Indian window the best it can ever be. The Villa Window is the world’s first twin-sash uPVC casement window system that integrates an insect mesh and a security grill with airtight protection against noise, rain and rising energy costs.

Integrated grill

The security grill is an absolute necessity in homes across India. In traditional windows, the grill is screwed to the masonry whereas in the Villa Window, it is integrated with clamps making homes much safer.

Protection from insects and mosquitoes

In India, protection against mosquitoes is a universal window requirement. An insect mesh in the inner sash of the Villa Window system blocks the entry of mosquitoes and insects when you open the window for ventilation.

This is the first uPVC casement window in the world to accommodate a grill in the same frame as a mesh.

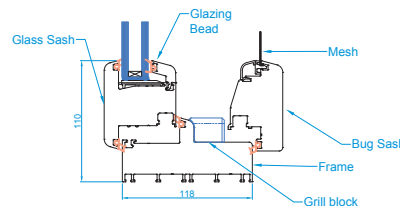

Cross Section of Villa Window with integrated mesh and grill.



Fenesta Villa Window with security grill and bug mesh in Walnut finish

2 Million+
Installations
Because experience counts

Experience of 2.5 Million Plus Installation

10 YEAR
Fenesta
WARRANTY

10 Year Warranty

365 Days
Customer Support

International Designs

Professional Installation

24X7 Live Chat on WhatsApp

Not Just a Brand, But A Superbrand

World Class Infrastructure

Mobile Studio



Stage I:

Your requirements identified: Should the windows tackle noise in your neighborhood/project? Or dust? Or rain? Or wind? Or lack of sunlight?

Stage II:

The best possible customised solutions found: Fenesta experts recommend the most effective long-term solutions, windows that work best in your project for all time to come.

Stage III:

Survey followed by fabrication: The process involves precise measurements of each aperture. Technical drawings are then sent to the production team for fabrication.

Stage IV:

Delivery and installation: The windows arrive at your site at the appointed date. Installation is carried out once the civil work is complete. The installation process involves the use of anchor fasteners and sealants between the wall and the frame.

Stage V:

Handover: Once the installation is complete, technicians carry out a practical demonstration of each window for your benefit.

Stage VI:

Your feedback: Post installation, the team leader calls you for a 'Customer Satisfaction' Survey. You are requested to rate your Fenesta experience. Your feedback helps in improving the standards of Fenesta service.

Stage VII:

After Sales Service: Our customer service cell works for 365 days. You can **call us at 1800 102 9880, 74286 91568, SMS WINDOW to 56161, or email at response@fenesta.com** for any help that you require for smooth operations of your windows.

The Fenesta Product Range - Windows and Doors



The Villa Window

A rare combination of style and substance, the Villa Window when launched was the first to introduce a twin sash, bug mesh and a grill built in the system. This ensures enhanced security and ventilation while not allowing insects and mosquitoes inside.

Available in uPVC.

The Tilt and Turn Window

Welcome more sunlight and ventilation inside your home with these Tilt & Turn windows. Featuring a sash that can tilt open at an angle from the top with hinges at the bottom or can swing inwards with hinges on the side.

Advanced engineering facilitates both these operations with the simple turn of a single handle.

Available in uPVC and Aluminium.

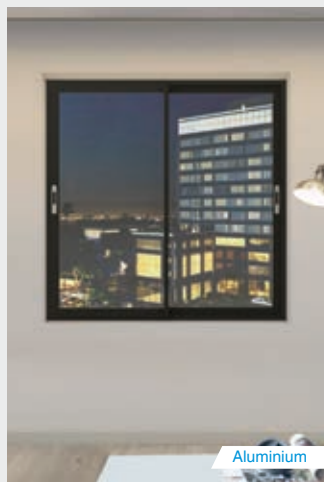
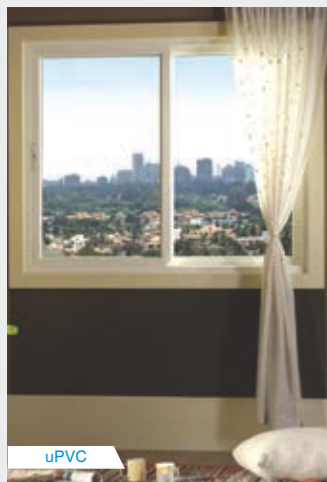
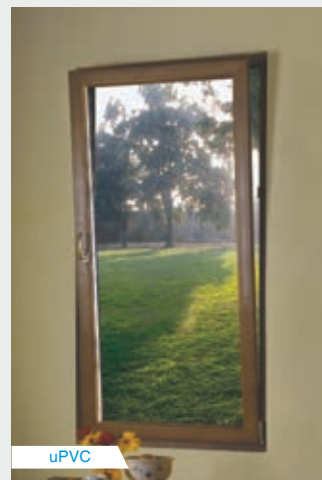

The Slider Window and Door

Featuring horizontal sashes fitted with rollers at the bottom, these windows optimize space with their swift sideways movement. Easy to open and shut, the slider gives you great ventilation and the widest view possible.

Available in uPVC and Aluminium.

The Casement Window

Featuring a sash that is hinged from the side on an outer frame that can open inwards and outwards. This ensures maximum ventilation in the room. Due to its double/triple glazing options, they enable better thermal and sound insulation as well. The windows come with multiple point locking systems and friction stay that ensure the window remains open in a fixed position even in the face of a stiff breeze.

Available in uPVC and Aluminium.

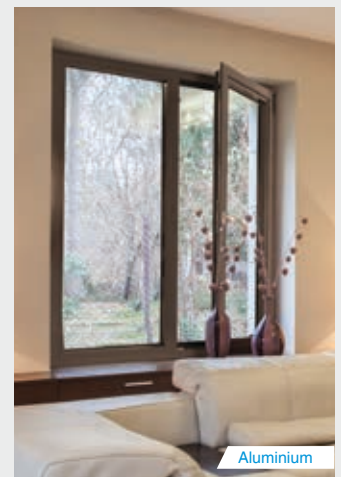

The Fenesta Product Range - Windows and Doors



uPVC



Aluminium

The Slide & Fold Door

Nothing looks or works better in rooms overlooking gardens and terraces. Fenesta Slide and Fold Door can elegantly and effortlessly connect your inside space with the environment outside. Stylish, contemporary and elegant, they offer a unique slide and fold mechanism that can divide and join large openings effortlessly. Fusion-welded frame and a sash for strength ensure that their beauty stays ageless.

Available in uPVC and Aluminium.

The Lift & Slide Door

Enjoy vast panoramic views with divider-less glass panes that offer superior insulation and enhanced security. Lift & Slide technology can connect inside with outside with just a feather touch.

Available in uPVC and Aluminium (Thermal Break System).



uPVC

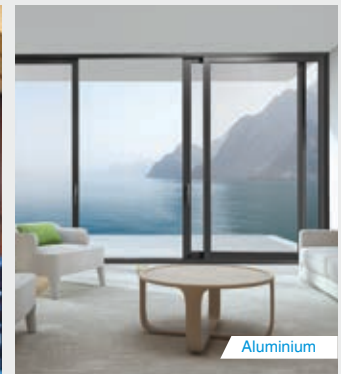

Aluminium



uPVC



Aluminium

90° Corner Slider

Keeping in mind the styles of contemporary homes, Fenesta introduces the 90° Corner Slider system. It is perfect for use in corners of balcony, garden spaces and facades.

Available in uPVC and Aluminium (Thermal Break System).

Glass-to-Glass Window

Features a fixed window unit, where the glass panes meet at an angle of 90° and are neatly joined together without using any mullions.

Available in uPVC.

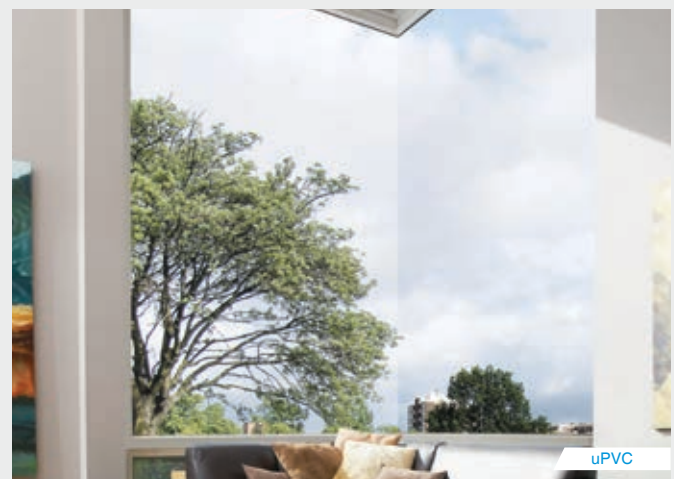

uPVC

The Fenesta Product Range - Windows and Doors



Low Threshold Slider

Comes with all the advantages of the slider doors with a lower threshold thus seamlessly connecting the home's indoor to outdoor. It also offers easy accessibility of wheelchair which reduces the chances of slipping and tripping.

Available in uPVC and Aluminium.

Casement Door

Counted among the most popular door designs, it gives a classic look in even the most modern of settings. Designed to swing inwards or outwards with the twist of a handle, Casement Doors offer clear views of the other side. Above all, it's their picturesque profile that makes Casement Doors the preferred choice for many. Casement Doors are equipped with hook locks and 3D hinges which ensure smooth operation with safety.

Available in uPVC and Aluminium.

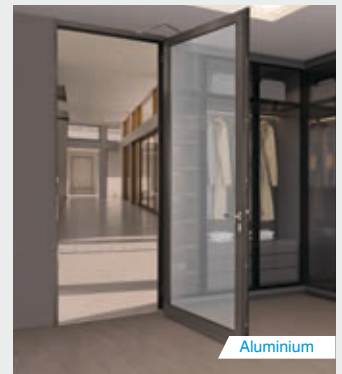

Internal Door

Fenesta doors are made of a special hybrid polymer. They are composite materials made of wood fibre and thermoplasts replacing traditional material, hence making them environment friendly. Hybrid polymer is very sturdy and makes the doors resistant to termite, water, moisture absorption, fire and wear & tear of weather. Unlike the old-style traditional doors, Fenesta doors are low maintenance, superior quality and last longer.

Designer Door

The Fenesta Designer door can be used at entrance, rooms, bathrooms, kitchen or anywhere else. The core is filled with a metal sheet and foam to enhance sound & thermal insulation and weather-endurance.



The Fenesta Project (Premium) Series



This range has been specially designed for projects

The Fenesta Project (Premium) Series is a value priced product suited to meet your needs for living room, bedroom and kitchen. Prepared from unique uPVC blend, this series is designed to handle wind loads upto 2000* Pascals, making it weather resistant, energy efficient, UV resistant, low maintenance and outlast building. Products made from Premium Series retain their shape and sheen for years together. Professional installation by the Fenesta installation team further ensures insulation against noise, dust and pollution.

Available in uPVC

COLOUR PALETTE



*Available in uPVC & Aluminium both. †Available in uPVC. *Available in Aluminium. ^Available in Internal Doors.

Slider Window System X-Section Sightline

- 1 Differential wall thickness for corner finish
- 2 Tapered base for water drainage
- 3 Sleeker profiles / bolder sightline
- 4 Common profiles & accessories

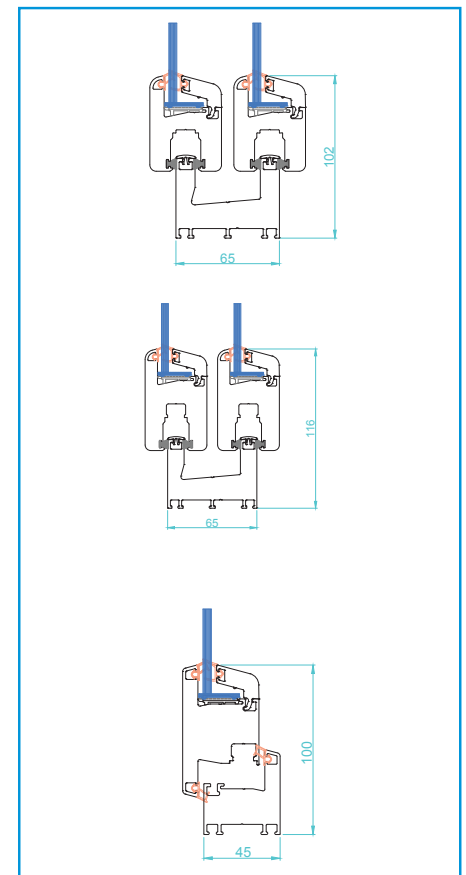

Slider Door System X-Section Sightline

- 1 Differential wall thickness for corner finish
- 2 Tapered base for water drainage
- 3 Sleeker sash / bold sightline
- 4 Common profiles & accessories

Casement Window System X-Section Sightline

- 1 Euro-groove for standard hardware
- 2 Tapered base for water drainage
- 3 Higher wind load rating
- 4 Common profiles & accessories

The Fenesta Project (Premium) Series









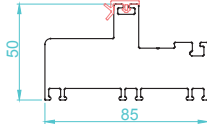

Premium Villa Window for projects

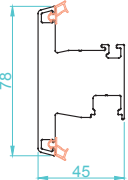

Villa window designs are created keeping in mind the standard benefits of the casement window, combining them with aesthetics. These windows are created especially for Indian homes which offer protection from various situations, including theft (grill) or insects (mesh) without having to sacrifice on the ventilation. They also come with multiple lock points which help in enhancing the security of your house.

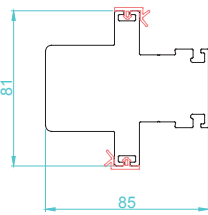
Available in uPVC

PREMIUM VILLA WINDOW

FRAME	ACCESSORIES
 <p>Drawing No - V45PF1</p>	 <p>Description - Single Glaze Bead Drawing No - A45PB1</p>
<h3>SASH</h3>	 <p>Description - Double Glaze Bead Drawing No - A65PB2</p>
 <p>Drawing No - C45PS1</p>	 <p>Description - Bug Bead Drawing No - B45PB1</p>
 <p>Drawing No - B45PS2</p>	 <p>Description - Bug Clip Drawing No - B65PO1</p>
<h3>TRANSOM / MULLION</h3>	<h3>GASKET</h3>
 <p>Drawing No - V45PT1</p>	 <p>V45GO1 FGR/FGL_R1 BGR_1_R1 BGR_3 BGR_5</p>

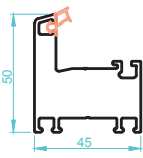
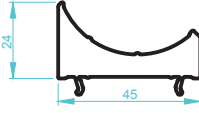
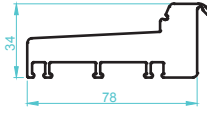
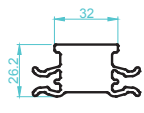
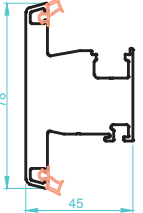
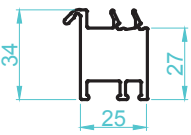
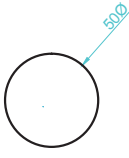
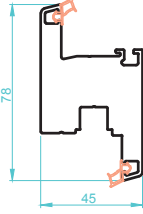
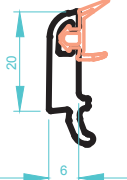
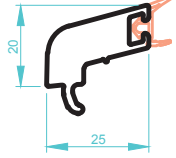
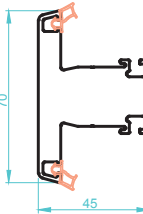
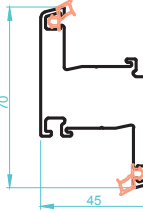
CASEMENT WINDOWS

	PROFILE	ACCESSORIES		
OUTER FRAMES	 <p>Casement - Outer Frame Drawing No - C45PF2</p>	 <p>BB Adaptor Drawing No - C45PO1</p>	 <p>Sill Profile Drawing No - A65PO1</p>	 <p>Structural Coupler Drawing No - A65PO10</p>
SASH	 <p>Casement - T Sash Drawing No - C45PS1</p>	 <p>Wall Connector Drawing No - A65PO2</p>	 <p>C56 Py1 BAY POLE</p>	
	 <p>Casement - Z Sash Drawing No - C45PS2</p>	 <p>Double Glaze Bead Drawing No - A65PB2</p>	 <p>Glass Bead Drawing No - A45PB1</p>	
TRANSOM/MULLION	 <p>Casement - T Mullion Drawing No - C45PT1</p>			
	 <p>Casement - Z Mullion Drawing No - C45PT2</p>	<p>GASKET</p>  <p>FGR/FGL_R1 BGR 1_R1 BGR 3 BGR 5</p>		

The Fenesta Impact

On Homes:



Our homes are a reflection of our personality. At Fenesta, we strongly believe in this, and as India's largest windows and doors brand, we are committed to providing the best solutions for every home in India. Our wide range includes innovative yet beautiful solutions for every room of your house making it brighter, bigger and even cleaner. Each of our products is a perfect combination of art and science, created as per your environment - Wind Speeds, Rainfall Intensity - and Architectural tastes. So read on and discover how Fenesta won't just transform your home but change the way you live for all times to come.

- Freedom from noise, dust and pollution
- Energy efficiency: reduced electricity bills, comfortable living with minimal environmental impact
- No rain seepage
- Bright and airy rooms
- Specially engineered windows that withstand strong winds: no rattling and whistling
- An uninterrupted view of the world outside
- The merging of balconies and rooms: more space
- A flawless finish: superior aesthetics
- Freedom from maintenance
- A lifelong investment

On Hotels:

Our window and door solutions, with their superior insulation and stunning aesthetics, create a contemporary and luxurious ambience within a hotel room offering guests privacy and comfort of a home. As a result, over 100 luxurious Indian hotels have installed Fenesta.

- Reduces air-conditioning costs by as much as 30% in some cases
- Ensures privacy and noise free environment for guests
- Brightens up the environment
- Improves the view
- Creates space: Unites balconies with rooms
- Blocks noise, rain, wind, dust and pollution
- Reduces street noise by as much 45 decibels
- Increases ventilation (as and when you need to)
- Reduces maintenance costs



On Hospitals:



Advanced insulation properties of our windows and doors protect the patients from noise, dust and pollution, maintaining the much needed peaceful and sterile environment inside. It also makes us the preferred choice of India's leading hospitals.

- Peace and quiet that helps patients recover
- Superior hygiene
- Bright rooms: Sunlight without heat
- Energy saving: Lower air-conditioning costs
- Virtually zero maintenance

These are few reasons why hospitals across India have transformed their environment simply by switching to Fenesta.

Our Clientele:

Residential



Crest NCR, Belair NCR, Park Place NCR
OMR Chennai, Vytilla Cochin & NTH Calcutta



Shantiniketan Bangalore, Abshot -
Bangalore, Bougain Villa - Bangalore more



Atlantis - NCR, Pirangut
Villas - Pune



Blue Sapphire - Kolkata



Iconic - NCR, Mezzaria - NCR,
Moderne - NCR



Twin Towers - NCR,
Forest Spa - NCR



Solitaire - Hyberabad



Klasse - NCR



Woodsman Estate - Bangalore



Chloris - NCR, Aura - NCR



Stylome - NCR, Edifice - NCR



Millenium - Bangalore, Gardenia -
Bangalore, Splendor - Bangalore,
Harmony, Paramount more



Blue Mont - Chennai,
West Hills - Chennai

Hotels



Cochin, Landsend,
Mumbai, Hyderabad



NCR



NCR



NCR



Bangalore



Pune, Ahmedabad, Chennai



Gurgaon, Goa, Ahmedabad, Mumbai



NCR



Bangalore, Goa, Hyderabad



Ahmedabad, Indore



NCR

Hospitals



NCR



Mumbai, Bangalore



Chennai



Mumbai



Mumbai



NCR



NCR



Scan this for a 360° VR enabled
walk through of our showroom



Explore more with the AR enabled
Fenesta App



Scan to download the app



India's No.1 Windows & Doors Brand

Nationwide Footprint: Service across 327+ cities

Call: 1800 102 9880 (Toll Free) | 74286 91568 | SMS: WINDOW to 56161 | Visit: www.fenesta.com

Fenesta Head Office: Ground Floor, Plot No. 52, Sector - 32, Gurgaon

CHANGE THE WAY YOU LIVE

Keep the Outside Outside Forever



Fenesta 
Better by Design

India's No.1 Windows & Doors Brand



Fenesta floor-to-ceiling slider in walnut finish

Happiness inside.
Worries outside.

No surprises why people prefer Fenesta

Be it the harsh elements of nature, the follies of irresponsible industrialisation, smoke spewing vehicles, the cacophony of chaos or the fear of not getting the right service - Fenesta keeps them out, forever. All that it allows to come in, is goodness and the assurance of having made the right choice.

Fenesta. India's No.1 Windows and Doors Brand

No one else has the experience of over 2.5 million installations in more than 2,00,000 homes and numerous hotels, hospitals, schools and offices across the country. No one else has the infrastructure to offer a complete-end-to-end solution, from the selection of designs, site surveys and fabrication at state-of-the-art factories to installation and after-sales service. The elaborate nationwide infrastructure serves 327+ cities and comprises four factories, nine Signature Studios, over 200 partner showrooms, a service and sales force of 1000 and a customer service center on call 365 days. The sheer weight of these numbers makes Fenesta not just India's number one brand in windows and doors but India's only Superbrand in fenestration.

Keeps Noise Out

Welded joints, double seals and multiple-point locks make them virtually airtight, reducing the menace of street noise. Traditional windows, on the other hand, have gaps in the frame as well as between the wall and the frame, inviting unwanted noise.

Keeps Rain Seepage Out

To keep out lashing horizontal rain, Fenesta has engineered three special mechanisms: the Rain Track, the Gradient Slope and the Sill Arrangement. Traditional windows have none of these. In fact, when wooden windows warp – as they often do – rain flows indoors through gaps. Aluminium windows too are not designed to prevent rain seepage.

Keeps the Effects of Stormy Weather Out

With utmost ease because their broader sections are fortified with thicker steel reinforcements and a special invention called the 'Hurricane Bar'. Conventional windows are much weaker. They develop narrow air gaps that allow winds to whistle through. They also start rattling.

Keeps the Effects of Wood Out

A wooden window expands in the monsoons and contracts in the heat. Over time, it loses not just its shape and colour but also its ability to perform. They warp, chip and are open to termite attacks, cracks appear through which noise, dust, pollution and rain enter your home. In a few years, you'll need to replace it. Fenesta, on the other hand, is immune to seasons and continues to perform year after year.

Keeps High Energy Costs Out

Poor sealing in conventional windows raises air-conditioning costs. The problem magnifies with low cost aluminium – a good conductor of heat. In sharp contrast, Fenesta is a poor conductor of heat. In addition, superior sealing, both in the window frame and between the wall and the window prevents cold air from escaping and hot air from coming in. Rooms cool faster and thermostat cuts off sooner.

Keeps Mosquitos Out, Ventilation in

Fenesta has a special bug mesh integrated into both its sliders and casements (windows that open inwards and outwards). In the Villa window, the bug mesh is standard.

Keeps Worries of Proper Installation Out

Proper installation is crucial to long-term window performance. That's why Fenesta has qualified installation teams who follow a precise 9-step process. Unlike others, Fenesta teams have handled more than 2.5 million installations. In individual homes, the teams can install windows in a day without any disturbance to family life.

Keeps the Fear of Break-ins Out

Yes, they can and they do. The Fenesta Villa window, for instance, has an integrated grill clamped to the window frame – unlike traditional grills that are fitted in the masonry. Most Fenesta models come with multiple point locks and the option of grills and toughened glass.

After Sales Service in. Tension Out

Should you need any assistance at any time, just call the toll-free number (1800 102 9880). Open 365 days a year, the Fenesta Customer Service Center responds in a flash.

FENESTA Benefits: Science@work

Specially made for Indian Conditions



SCIENCE
@ WORK



Sound
Insulation



Saves Energy



Prevents Dust
Buildup



Insulation against
Pollution



Blocks Rainwater
Seepage



Elegant Looks



Storm Resistant



Weather Resistant



Low
Maintenance



<p>Experience of 2.5 Million Plus Installation</p>	<p>10 Year Warranty</p>	<p>365 Days Customer Support</p>
<p>International Designs</p>	<p>Professional Installation</p>	<p>24X7 Live Chat on WhatsApp</p>
<p>Not Just a Brand, But A Superbrand</p>	<p>World Class Infrastructure</p>	<p>Mobile Studio</p>



Stage I:

Your requirements identified: Should the windows tackle noise in your neighborhood/project? Or dust? Or rain? Or wind? Or lack of sunlight?

Stage II:

The best possible customised solutions found: Fenesta experts recommend the most effective long-term solutions, windows that work best in your project for all times to come.

Stage III:

Survey followed by fabrication: The process involves precise measurements of each aperture. Technical drawings are then sent to the production team for fabrication.

Stage IV:

Delivery and installation: The windows arrive at your site at the appointed date. Installation is carried out once the civil work is complete. The installation process involves the use of anchor fasteners and sealants between the wall and the frame.

Stage V:

Handover: Once the installation is complete, technicians carry out a practical demonstration of each window for your benefit.

Stage VI:

Your feedback: Post installation, the team leader calls you for a 'Customer Satisfaction' Survey. You are requested to rate your Fenesta experience. Your feedback helps in improving the standards of Fenesta service.

Stage VII:

After Sales Service: Our customer service cell works for 365 days. You can call us at **1800 102 9880**, **74286 91568**, SMS WINDOW to 56161, or email at **response@fenesta.com** for any help that you require for smooth operations of your windows.



The Villa Window

A rare combination of style and substance, the Villa Window when launched was the first to introduce a twin sash, bug mesh and a grill built in the system. This ensures enhanced security and ventilation while not allowing insects and mosquitoes inside.

Available in uPVC.

The Tilt and Turn Window

Welcome more sunlight and ventilation inside your home with these Tilt & Turn windows. Featuring a sash that can tilt open at an angle from the top with hinges at the bottom or can swing inwards with hinges on the side. Advanced engineering facilitates both these operations with the simple turn of a single handle.

Available in uPVC and Aluminium.

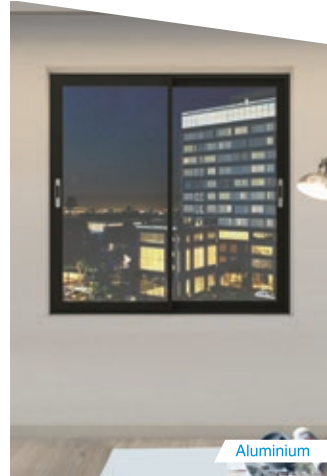
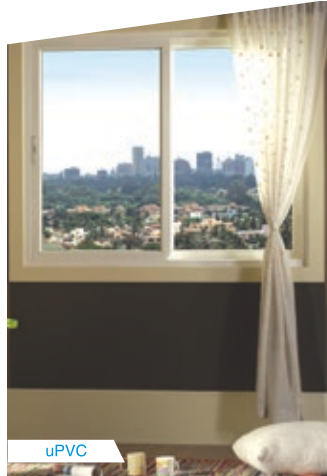
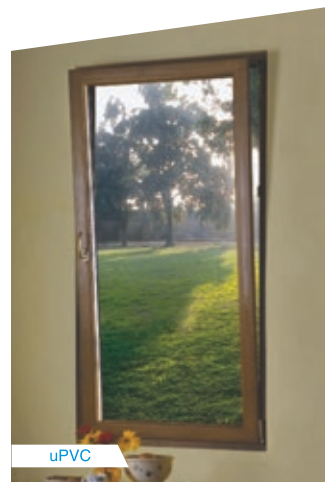

The Slider Window and Door

Featuring horizontal sashes fitted with rollers at the bottom, these windows optimize space with their swift sideways movement. Easy to open and shut, the slider gives you great ventilation and the widest view possible.

Available in uPVC and Aluminium.

The Casement Window

Featuring a sash that is hinged from the side on an outer frame that can open inwards and outwards. This ensures maximum ventilation in the room. Due to its double/triple glazing options, they enable better thermal and sound insulation as well. The windows come with multiple point locking systems and friction stay that ensures the window remains open in a fixed position even in the face of a stiff breeze.

Available in uPVC and Aluminium.

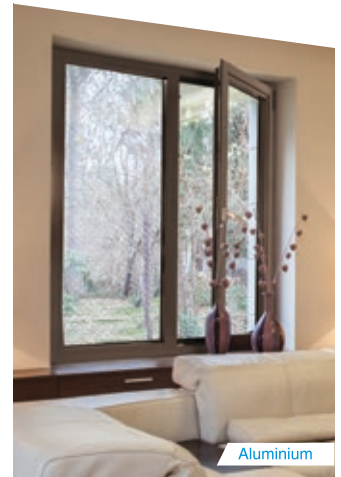



uPVC



Aluminium

The Slide & Fold Door

Nothing looks or works better in rooms overlooking gardens and terraces. Fenesta Slide and Fold Door can elegantly and effortlessly connect your inside space with the environment outside. Stylish, contemporary and elegant, they offer a unique slide and fold mechanism that can divide and join large openings effortlessly. Fusion-welded frame and a sash for strength ensure that their beauty stays ageless.

Available in uPVC and Aluminium.

The Lift & Slide Door

Enjoy vast panoramic views with divider-less glass panes that offer superior insulation and enhanced security. Lift & slide technology can connect inside with outside with just a feather touch.

Available in uPVC and Aluminium (Thermal Break System).



uPVC

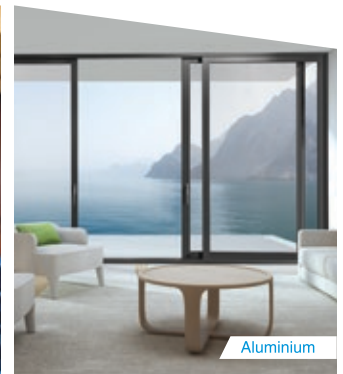

Aluminium



uPVC



Aluminium

90° Corner Slider

Keeping in mind the styles of contemporary homes, Fenesta introduces the 90° Corner Slider system. It is perfect for use in corners of balcony, garden spaces and facades.

Available in uPVC and Aluminium (Thermal Break System).

Glass-to-Glass Window

Features a fixed window unit, where the glass panes meet at an angle of 90° and are neatly joined together without using any mullions.

Available in uPVC.



uPVC



Low Threshold Slider

Comes with all the advantages of the slider doors with a lower threshold thus seamlessly connecting the home's indoor to outdoor. It also offers easy accessibility of wheelchair which reduces the chances of slipping and tripping.

Available in uPVC and Aluminium.

Casement Door

Counted among the most popular door designs, it gives a classic look in even the most modern of settings. Designed to swing inwards or outwards with the twist of a handle, Casement Doors offer clear views of the other side. Above all, it's their picturesque profile that makes Casement Doors the preferred choice for many. These Doors are equipped with hook locks and 3D hinges which ensure smooth operation with safety.

Available in uPVC and Aluminium.



Internal Door

Fenesta doors are made of a special hybrid polymer. They are composite materials made of wood fibre and thermoplasts replacing traditional material, hence making them environment friendly. Hybrid polymer is very sturdy and makes the doors resistant to termites, water, moisture absorption, fire and wear & tear of weather. Unlike the old-style traditional doors, Fenesta doors are low maintenance, superior quality and last longer.

Designer Door













The Fenesta Designer door can be used at entrance, rooms, bathrooms, kitchen or anywhere else. The core is filled with a metal sheet and foam to enhance sound & thermal insulation and weather-endurance.





COLOUR PALETTE

Experience Speaks

Residential

 Crest NCR, Belair NCR, Park Place NCR OMR Chennai, Vytilla Cochin & NTH Calcutta	 Shantiniketan Bangalore, Abshot - Bangalore, Bougain Villa Bangalore more	 Atlantis - NCR, Pirangut Villas - Pune	 Blue Sapphire - Kolkata	 Iconic - NCR, Mezzaria - NCR, Moderne - NCR	 Stylome - NCR, Edifice - NCR	 Blue Mont - Chennai, West Hills - Chennai
 Twin Towers - NCR, Forest Spa - NCR	 Solitaire - Hyberabad	 Klasse - NCR	 Woodsmen Estate - Bangalore	 Chloris - NCR, Aura NCR	 Millenium - Bangalore, Gardenia - Bangalore, Splendor - Bangalore, Harmony, Paramount more	

Hotels

 Cochin, Lansend, Mumbai, Hyderabad	 NCR	 NCR	 NCR	 Bangalore	 Gurgaon, Goa, Ahmedabad Mumbai
 NCR	 Bangalore, Goa, Hyderabad	 Ahmedabad, Indore	 NCR	 Pune, Ahmedabad, Chennai	

Hospitals

 NCR	 Mumbai, Bangalore	 Chennai	 Mumbai	 Mumbai
 NCR	 NCR			



**Building or renovating your home?
Call 1800 102 9880**



Scan this for a 360° VR enabled walk through of our showroom



Explore more with the AR enabled Fenesta App

Scan to download the app

Fenesta Signature Studio



Nationwide Footprint: Service across 327+ cities

Call: 1800 102 9880 (Toll Free) | WhatsApp: 74286 91568 | SMS: WINDOW to 56161 | Visit: www.fenesta.com

Fenesta Head Office: Ground Floor, Plot No. 52, Sector - 32, Gurgaon